

All rights reserved.

The information in this document is subject to change without notice.

Publish statement

Thank you for purchasing this series UPS.

This series UPS is an intelligent, single phase in single phase out, high frequency online UPS designed by our R&D team who is with years of designing experiences on UPS.

With excellent electrical performance, perfect intelligent monitoring and network functions, smart appearance, complying with EMC and safety standards, The UPS meets the world's advanced level.

Read this manual carefully before installation

This manual provides technical support to the operator of the equipment.

Table of Contents

- 1. Important Safety Warning 2
 - 1-1 Transportation 2
 - 1-2 Preparation 2
 - 1-3 Installation 2
 - 1-4 Operation 3
 - 1-5 Maintenance, service and faults..... 3
 - 1-6 Symbols used in this guide 4
- 2. Installation and setup 4
 - 2-1 Unpack checking..... 4
 - 2-2 Real panel view 4
 - 2-3 LCD control panel 6
 - 2-4 Setup the UPS..... 6
- 3. Operations 8
 - 3-1 Button operation 8
 - 3-2 LCD display..... 9
 - 3-3 UPS setting 11
 - 3-4 Operating Mode Description 14
 - 3-5 Operational Status and Mode(s)..... 14
 - 3-6 Alarm or Fault reference code 15
- 4. Troubleshooting 16
- 5. Storage and Maintenance 17
- 6. Specification 18

1. Important Safety Warning

Important safety instructions – Save these instructions

Please comply with all warnings and operating instructions in this manual strictly. Save this manual properly and read carefully the following instructions before installing the unit. Do not operate this unit before reading through all safety information and operating instructions carefully

There exists dangerous voltage and high temperature inside the UPS. During the installation, operation and maintenance, please abide the local safety instructions and relative laws, otherwise it will result in personnel injury or equipment damage. Safety instructions in this manual act as a supplementary for the local safety instructions. Our company will not assume the liability that caused by disobeyingsafety instructions.

1-1 Transportation

- Please transport the UPS system only in the original package to protect against shock and impact.

1-2 Preparation

- Condensation may occur if the UPS system is moved directly from cold to warm environment. The UPS system must be absolutely dry before being installed. Please allow at least two hours for the UPS system to acclimate the environment.
- Do not install the UPS system near water or in moist environments.
- Do not install the UPS system where it would be exposed to direct sunlight or near heater.
- Do not block ventilation holes in the UPS housing.

1-3 Installation

- Do not connect appliances or devices which would overload the UPS system (e.g. laser printers) to the UPS output sockets.
- Place cables in such a way that no one can step on or trip over them.
- Do not connect domestic appliances such as hair dryers to UPS output sockets.
- The UPS can be operated by any individuals with no previous experience.
- Connect the UPS system only to an earthed shockproof outlet which must be easily accessible and close to the UPS system.
- Please use only VDE-tested, CE-marked mains cable (e.g. the mains cable of your computer) to connect the UPS system to the building wiring outlet (shockproof outlet).
- Please use only VDE-tested, CE-marked power cables to connect the loads to the UPS system.
- When installing the equipment, it should ensure that the sum of the leakage current of the UPS and the connected devices does not exceed 3.5mA.

1-4 Operation

- Do not disconnect the mains cable on the UPS system or the building wiring outlet (shockproof socket outlet) during operations since this would cancel the protective earthing of the UPS system and of all connected loads.
- The UPS system features its own, internal current source (batteries). The UPS output sockets or output terminals block may be electrically live even if the UPS system is not connected to the building wiring outlet.
- In order to fully disconnect the UPS system, first press the OFF/Enter button to disconnect the mains.
- Prevent no fluids or other foreign objects from inside of the UPS system.

1-5 Maintenance, service and faults

- The UPS system operates with hazardous voltages. Repairs may be carried out only by qualified maintenance personnel.
- **Caution** - risk of electric shock. Even after the unit is disconnected from the mains (building wiring outlet), components inside the UPS system are still connected to the battery and electrically live and dangerous.
- Before carrying out any kind of service and/or maintenance, disconnect the batteries and verify that no current is present and no hazardous voltage exists in the terminals of high capability capacitor such as BUS-capacitors.
- Only persons are adequately familiar with batteries and with the required precautionary measures may replace batteries and supervise operations. Unauthorized persons must be kept well away from the batteries.
- **Caution** - risk of electric shock. The battery circuit is not isolated from the input voltage. Hazardous voltages may occur between the battery terminals and the ground. Before touching, please verify that no voltage is present!
- Batteries may cause electric shock and have a high short-circuit current. Please take the precautionary measures specified below and any other measures necessary when working with batteries:
 - remove wristwatches, rings and other metal objects
 - use only tools with insulated grips and handles.
- When changing batteries, install the same number and same type of batteries.
- Do not attempt to dispose of batteries by burning them. This could cause battery explosion.
- Do not open or destroy batteries. Escaping electrolyte can cause injury to the skin and eyes. It may be toxic.
- Please replace the fuse only with the same type and amperage in order to avoid fire hazards.
- Do not dismantle the UPS system.

1-6 Symbols used in this guide



WARNING!

Riskofelectricschock



CAUTION!

Readthisinformationtoavoidequipmentdamage

2. Installation and setup

NOTE: Before installation, please inspect the unit. Be sure that nothing inside the package is damaged. Please keep the original package in a safe place for future use.

2-1 Unpack checking

- Don't lean the UPS when moving it out from the packaging
- Check the appearance to see if the UPS is damaged or not during the transportation, do not switch on the UPS if any damage found. Please contact the dealer right away.
- Check the accessories according to the packing list and contact the dealer in case of missing parts.

2-2 Real panel view

1KVA(S):

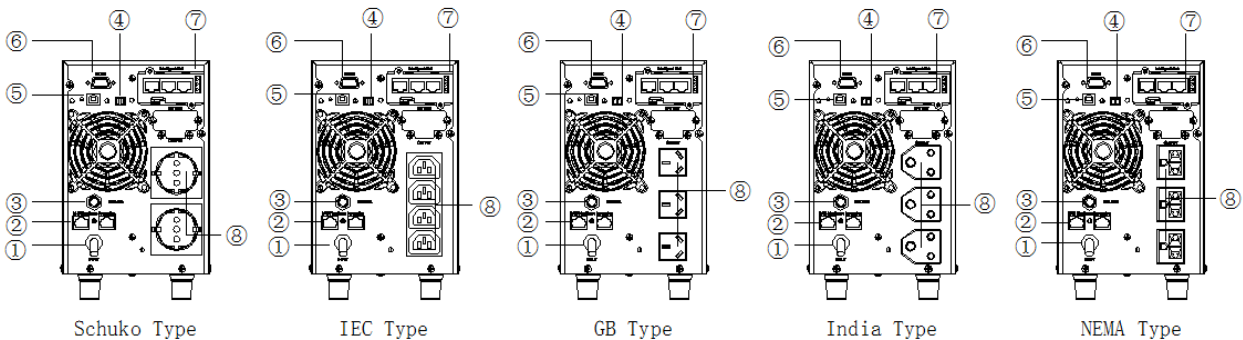

1KVA(H):

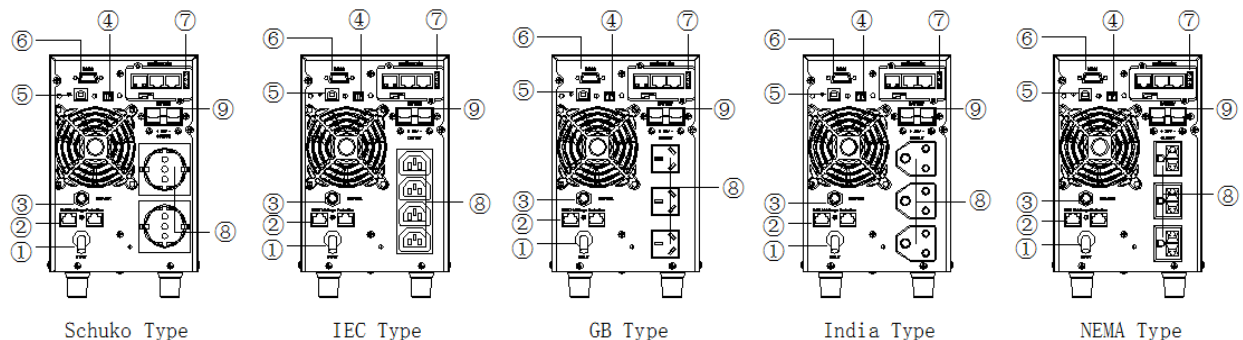

2KVA(S):

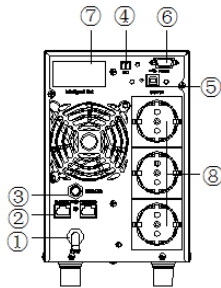

Schuko Type

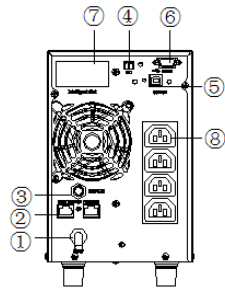

IEC Type

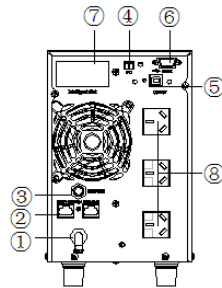

GB Type

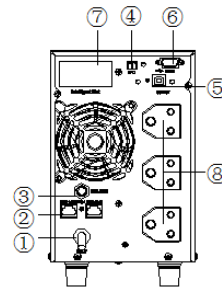

India Type

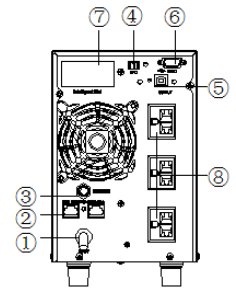

NEMA Type

2KVA(H)/3KVA(H)

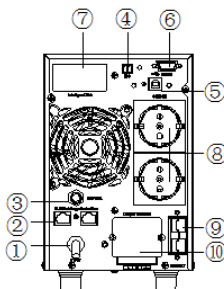

Schuko Type

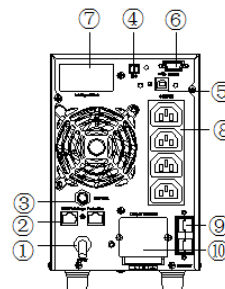

IEC Type

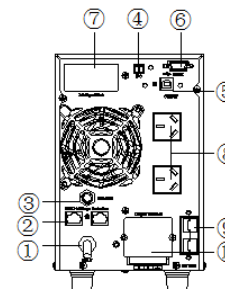

GB Type

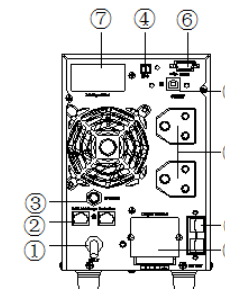

India Type

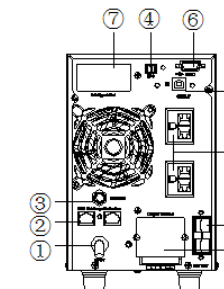

NEMA Type

3KVA(S):

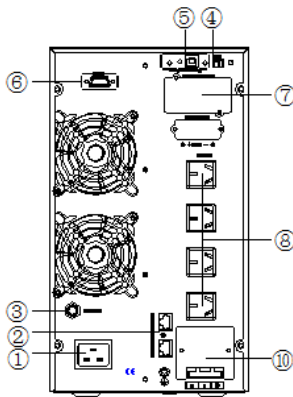

GB Type

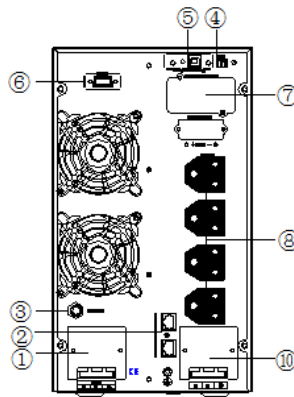

India Type

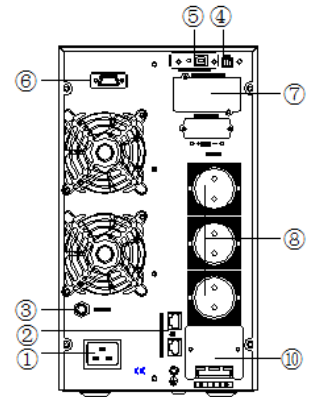

Schuko Type

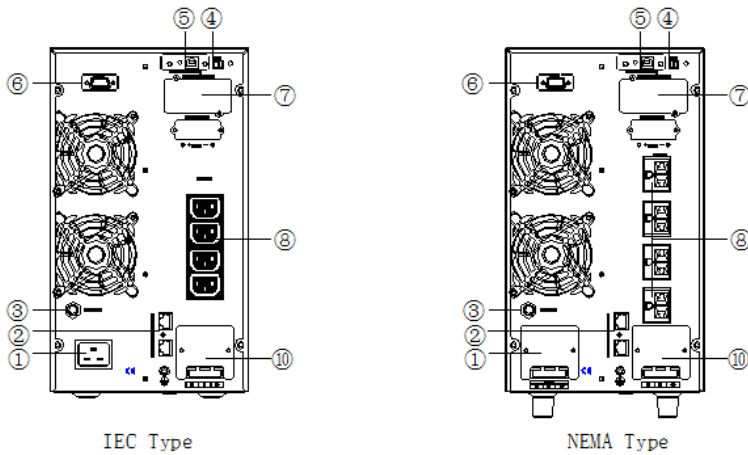

- 1. AC input
- 2. Network /Fax/Modem Surge Protection(option)
- 3. Input circuit breaker
- 4. EPO(option)
- 5. USB communication port(option)
- 6. RS-232 communication port
- 7. SNMP intelligent slot (option)
- 8. Output receptacles
- 9. Battery Terminal
- 10. Output Terminal

2-3 LCD control panel

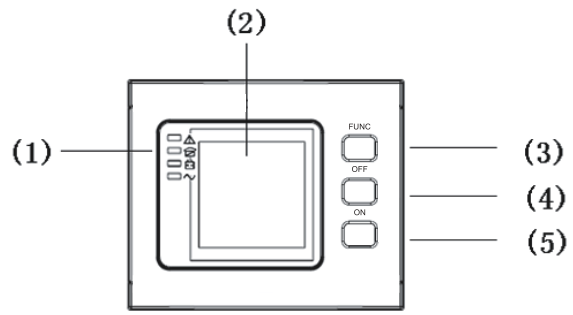

LCD control panel introduction

(1) LED (from top to bottom: “alarm”, “bypass”, “battery”, “inverter”) (2) LCD display (3) Selectbutton:enter to next item (4) Off button (5) On button

2-4 Setup the UPS

Step 1: UPS input connection

Plug the UPS into a two-pole, three-wire, grounded receptacle only. Avoid using extension cords.

- For 200/208/220/230/240VAC models: The power cord is supplied in the UPS package.

Step 2: UPS output connection

- For socket-type outputs, simply connect devices to the outlets.
- For terminal-type input or outputs, please follow below steps for the wiring configuration:
 - a) Remove the small cover of the terminal block
 - b) Suggest using AWG14 or 2.1mm² power cords for 3KVA (200/208/220/230/240VAC models).
 - c) Upon completion of the wiring configuration, please check whether the wires are securely affixed.
 - d) Put the small cover back to the rear panel.

Step 3 Communication connection

Communication port:

USB port



RS-232 port

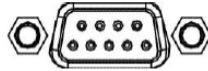

Intelligent slot



To allow for unattended UPS shutdown/start-up and status monitoring, connect the communication cable one end to the USB/RS-232 port and the other to the communication port of your PC. With the monitoring software installed, you can schedule UPS shutdown/start-up and monitor UPS status through PC.

The UPS is equipped with intelligent slot perfect for either SNMP or Relay card. When installing either SNMP or Relay card in the UPS, it will provide advanced communication and monitoring options.

NOTE: USB port and RS-232 port can't work at the same time.

Step 4: Turn on the UPS

Press the ON button on the front panel for two seconds to power on the UPS.

Note: The battery charges fully during the first five hours of normal operation. Do not expect full battery run capability during this initial charge period.

Step 5: Install software

For optimal computer system protection, install UPS monitoring software to fully configure UPS shutdown. You may insert provided CD into CD-ROM to install the monitoring software.

Step 6: External battery connection

If your UPS is not including batteries. Please connect external batteries as below chart.

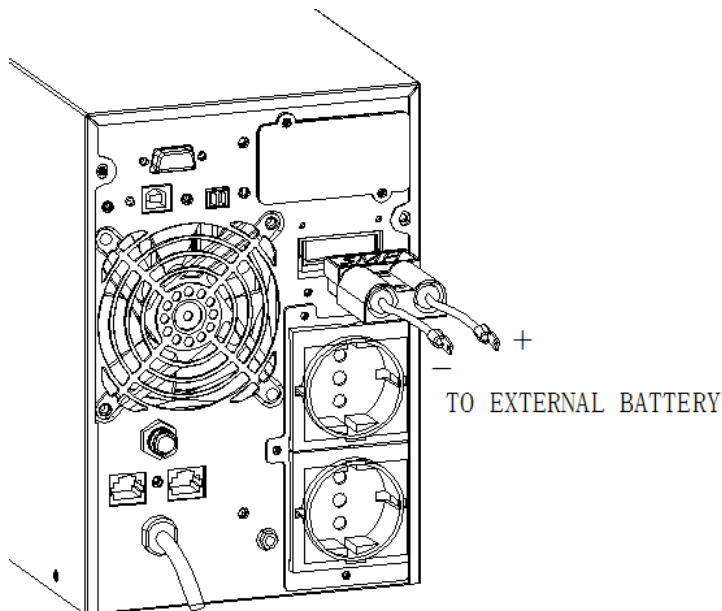

3. Operations

3-1 Button operation

Button	Function
ON Button	<ul style="list-style-type: none"> ➤ Turn on the UPS: Press and hold ON button for at least 2 seconds to turn on the UPS. ➤ Down key: Press this button to display next selection in UPS setting mode. ➤ Exit setting mode: Press this button to confirm selection and exit setting mode when LCD display the last selection in UPS setting mode.
OFF Button	<ul style="list-style-type: none"> ➤ Turn off the UPS: Press and hold this button at least 2 seconds to turn off the UPS in battery mode. UPS will be in standby mode under power normal or transfer to Bypass mode if the Bypass enable setting by pressing this button. ➤ Switch to bypass mode: When the main power is normal, press and hold this button for 2 seconds. Then UPS will enter to bypass mode. This action will be ineffective when the input voltage is out of acceptable range. ➤ Up key: Press this button to display previous selection in UPS setting mode.
Select/Mute Button	<ul style="list-style-type: none"> ➤ Switch LCD message: Press this button to change the LCD message for input voltage, input frequency, battery voltage, output voltage and output frequency etc. ➤ Mute the alarm: When the UPS is on battery mode, press and hold this button for at least 2 seconds to disable or enable the alarm system. But it's not applied to the situations when warnings or errors occur. ➤ Switch to UPS self-test mode: Press and hold this button for 2 seconds to enter UPS self-testing while in AC mode.
OFF + Select Button	<ul style="list-style-type: none"> ➤ Setting mode: Press and hold this button for 5 seconds to enter UPS setting mode.

3-2 LCD display

There are 8 interfaces available in the LCD display

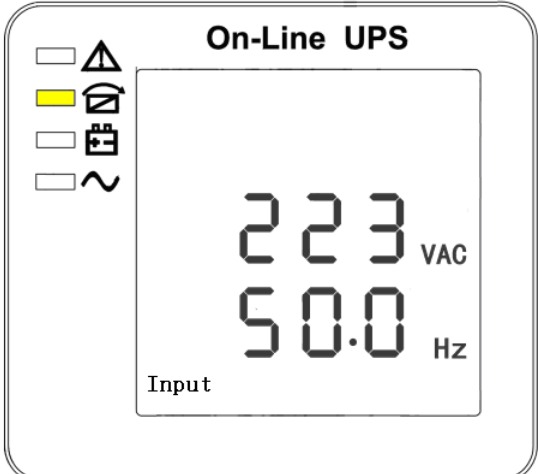
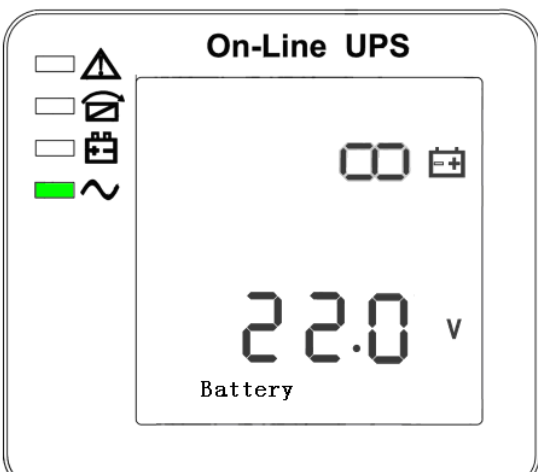
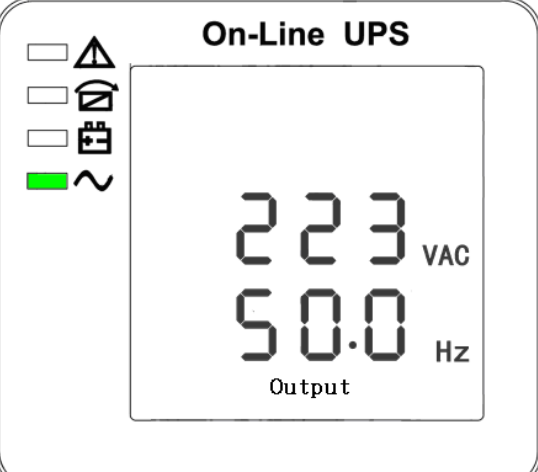
Item	Interface Description	Content Displayed
01	Input voltage	 <p>The LCD display shows 'On-Line UPS' at the top. On the left, there are four status indicators: a white triangle, a yellow battery, a white battery, and a white sine wave. The main display area shows '223 VAC' and '50.0 Hz' in large digits. The word 'Input' is displayed at the bottom left of the display area.</p>
02	Battery voltage	 <p>The LCD display shows 'On-Line UPS' at the top. On the left, there are four status indicators: a white triangle, a white battery, a white battery, and a green sine wave. The main display area shows '00' with a battery icon and '22.0 V' in large digits. The word 'Battery' is displayed at the bottom left of the display area.</p>
03	Output voltage	 <p>The LCD display shows 'On-Line UPS' at the top. On the left, there are four status indicators: a white triangle, a white battery, a white battery, and a green sine wave. The main display area shows '223 VAC' and '50.0 Hz' in large digits. The word 'Output' is displayed at the bottom left of the display area.</p>

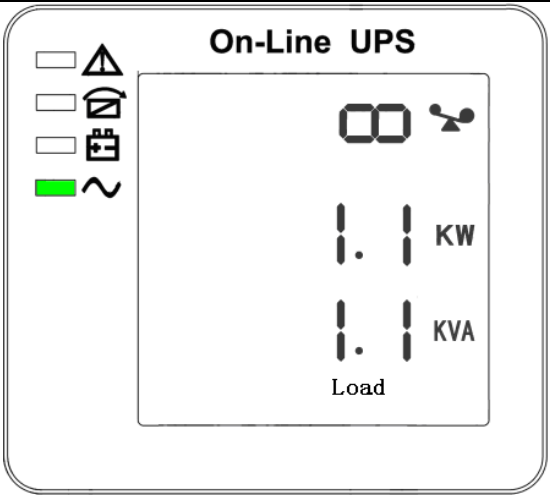
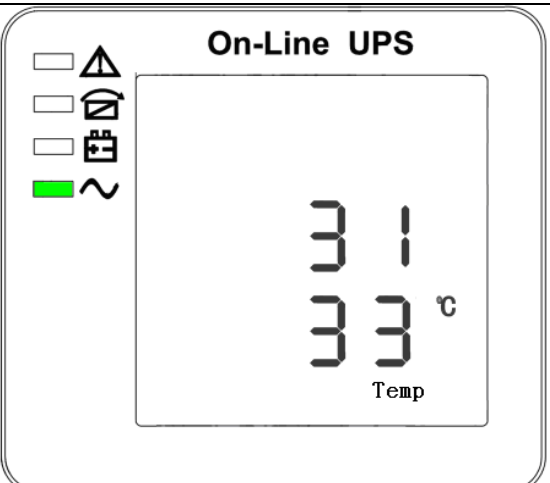
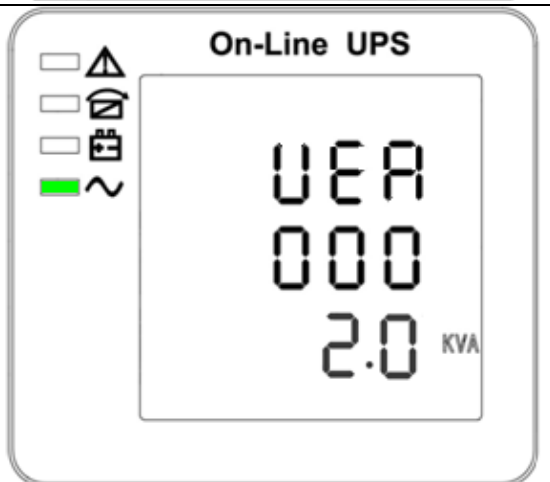
04	Load	 <p>The display shows 'On-Line UPS' at the top. On the left, there are four status indicators: a triangle with a slash, a house with a slash, a battery with a slash, and a sine wave. The first three are empty, and the fourth is filled green. The main display area shows '00' with a sine wave icon, '1.1 KW', '1.1 KVA', and 'Load' at the bottom.</p>
05	Temperature (Environment Temperature & Heatsink Temperature)	 <p>The display shows 'On-Line UPS' at the top. On the left, there are four status indicators: a triangle with a slash, a house with a slash, a battery with a slash, and a sine wave. The first three are empty, and the fourth is filled green. The main display area shows '31' and '33 °C' with 'Temp' at the bottom.</p>
06	Firmware Version & UPS model.	 <p>The display shows 'On-Line UPS' at the top. On the left, there are four status indicators: a triangle with a slash, a house with a slash, a battery with a slash, and a sine wave. The first three are empty, and the fourth is filled green. The main display area shows 'UEA', '000', and '2.0 KVA'.</p>

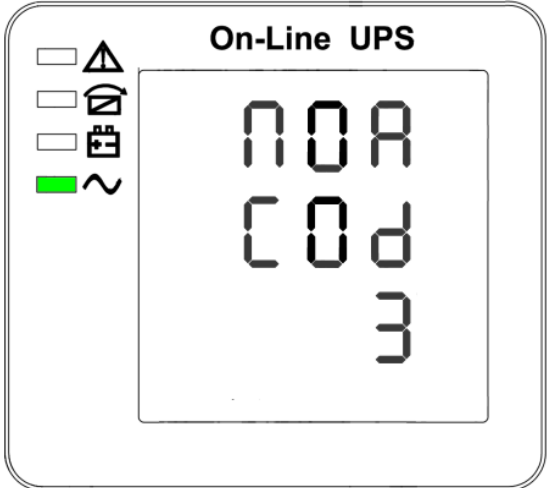
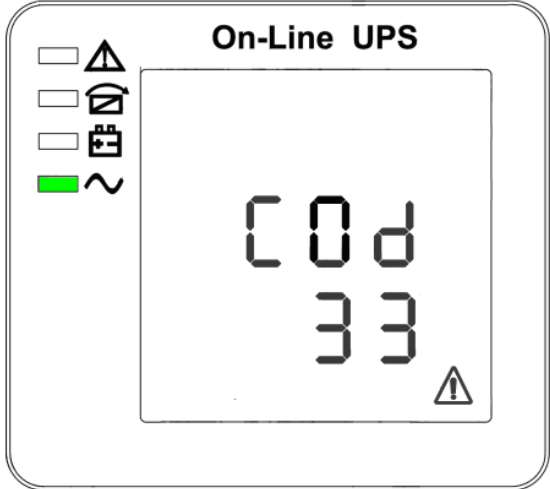
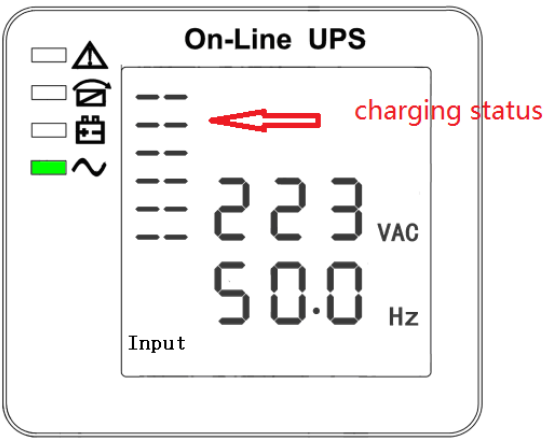
07	CODE (Operational status and mode)	 <p>The display shows 'On-Line UPS' at the top. On the left, there are four status indicators: a triangle, a square with a diagonal line, a square with a grid, and a sine wave. The main display area shows '00A' on the top line, 'COd' on the second line, and '3' on the third line.</p>
08	Alarm Code(Warming Message) All alarm codes are present when abnormal behavior(s) occur(s)	 <p>The display shows 'On-Line UPS' at the top. On the left, there are four status indicators. The main display area shows 'COd' on the top line, '33' on the second line, and a warning triangle icon on the bottom right.</p>
09	The charging status can also be shown on the screen as below while the charger is on.	 <p>The display shows 'On-Line UPS' at the top. On the left, there are four status indicators. The main display area shows '---' on the top line, '223 VAC' on the second line, and '50.0 Hz' on the third line. Below the second line, the word 'Input' is visible. A red arrow points to the '---' on the top line, with the text 'charging status' next to it.</p>

3-3 UPS setting

The setting function is controlled by 3 buttons (Enter/Select \cup , Off/up \blacktriangle , On/down \blacktriangledown): Enter \cup +Off/up \blacktriangle ---goes into the setting page, Enter \cup --- value adjustment; Off \blacktriangle & On \blacktriangledown ---for choosing different pages.

After the UPS turn ON, press buttons \cup & \blacktriangle for 5seconds and then goes into the setting interface page.

Note: Figure at left corner is the page number of the setting pages.

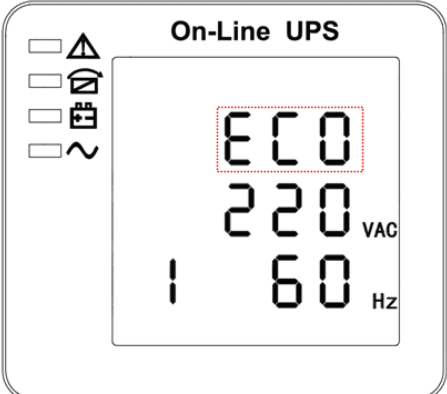
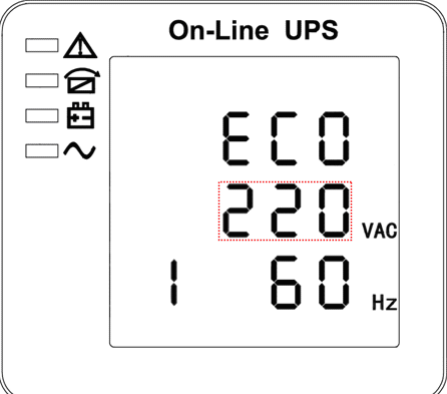
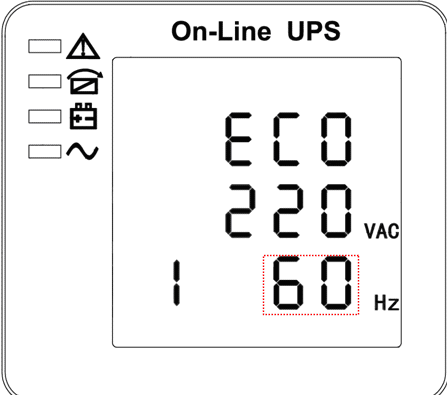
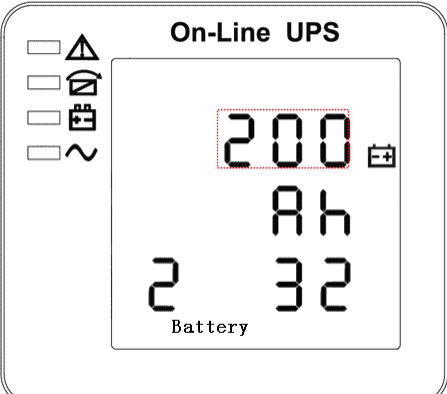
Item	Settings	Content Displayed
01	<p>Mode setting</p> <p>Press select button \cup to change the setting (ECO or NOR).</p> <p>Press UP button \blacktriangle to select the previous setting.</p> <p>Press DOWN \blacktriangledown button to select the next setting.</p>	 <p>The display shows 'On-Line UPS' at the top. On the left, there are four icons: a triangle, a square with a diagonal line, a square with a plus sign, and a sine wave. The main display area shows 'ECO' in a red dashed box, '220 VAC', and '1 60 Hz'.</p>
02	<p>Output voltage setting</p> <p>Press select button \cup to change the setting (100,110,115,120,127 or 200,208, 220, 230, 240).</p> <p>Press UP button \blacktriangle to select the previous setting.</p> <p>Press DOWN \blacktriangledown button to select the next setting.</p>	 <p>The display shows 'On-Line UPS' at the top. On the left, there are four icons: a triangle, a square with a diagonal line, a square with a plus sign, and a sine wave. The main display area shows 'ECO', '220 VAC' in a red dashed box, and '1 60 Hz'.</p>
03	<p>Frequency setting</p> <p>Press select button \cup to change the setting (50 or 60Hz).</p> <p>Press UP button \blacktriangle to select the previous setting.</p> <p>Press DOWN \blacktriangledown button to select the next setting.</p>	 <p>The display shows 'On-Line UPS' at the top. On the left, there are four icons: a triangle, a square with a diagonal line, a square with a plus sign, and a sine wave. The main display area shows 'ECO', '220 VAC', and '1 60 Hz' in a red dashed box.</p>
04	<p>Battery capacity setting</p> <p>Press select button \cup to change the setting (Battery capacity range is 1-200Ah).</p> <p>Press UP button \blacktriangle to select the previous setting.</p> <p>Press DOWN \blacktriangledown button to select the next setting.</p>	 <p>The display shows 'On-Line UPS' at the top. On the left, there are four icons: a triangle, a square with a diagonal line, a square with a plus sign, and a sine wave. The main display area shows '200 Ah' in a red dashed box, '2 32', and 'Battery' at the bottom.</p>

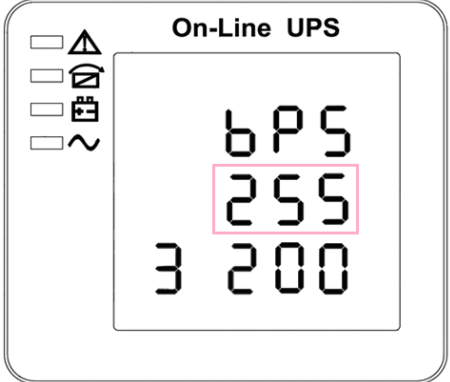
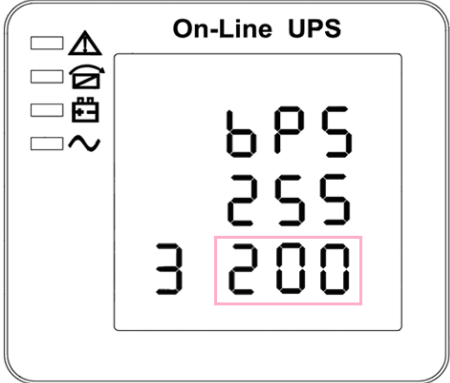
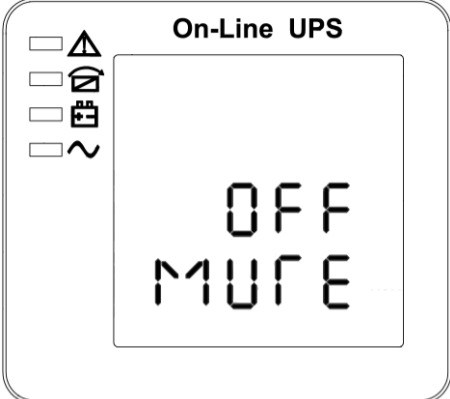
<p>05</p>	<p>Bypass voltage upper limit setting</p> <p>Press select button \cup to change the setting(The bypass voltage upper limit range is 230-264Vac).</p> <p>Press UP button \blacktriangle to select the previous setting.</p> <p>Press DOWN \blacktriangledown button to select the next setting.</p>	
<p>06</p>	<p>Bypass voltage lower limit setting</p> <p>Press select button \cup to change the setting(The bypass voltage lower limit range is 170-220Vac).</p> <p>Press UP button \blacktriangle to select the previous setting.</p> <p>Press DOWN \blacktriangledown button to select the next setting.</p>	
<p>07</p>	<p>Mute setting</p> <p>Press select button \cup to change the setting(ON or OFF).</p> <p>Press UP button \blacktriangle to select the previous setting.</p> <p>Press DOWN \blacktriangledown button to save and exit the setup.</p>	

3-4 Operating Mode Description

Operating mode	Description	Display
Online mode	When the input voltage is within acceptable range, UPS will provide pure and stable AC power to output. The UPS will also charge the battery at online mode.	Inverter led light
ECO mode	Energy saving mode: When the input voltage is within voltage regulation range, UPS will bypass voltage to output for energy saving.	Bypass led light
Battery mode	When the input voltage is beyond the acceptable range or power failure and alarm is sounding every 4 second, UPS will backup power from battery.	Battery led light
Standby mode	UPS is powered off and no output supply power, but still can charge batteries.	All LEDs turn off
Bypass mode	When input voltage is within acceptable range but UPS is overload, UPS will enter bypass mode or bypass mode can be set by front panel.	Bypass led light

3-5 Operational Status and Mode(s)

item	Content Displayed
1	Initialized
2	Standby Mode
3	No Output
4	Bypass Mode
5	Utility Mode
6	Battery Mode
7	Battery Self-diagnostics
8	Inverter is starting up
9	ECO Mode
10	EPO Mode
11	Maintenance Bypass Mode
12	Fault Mode

3-6 Alarm or Fault reference code

Event log	UPS Alarm Warning	Buzzer	LED
1	Rectifier Fault	Beep continuously	Fault LED lit
2	Inverter fault(Including Inverter bridge is shorted)	Beep continuously	Fault LED lit
9	Fan fault	Beep continuously	Fault LED lit
12	Selftest fault	Beep continuously	Fault LED lit
13	Battery Charger fault	Beep continuously	Fault LED lit
15	DC Bus over voltage	Beep continuously	Fault LED lit
16	DC Bus below voltage	Beep continuously	Fault LED lit
17	DC bus unbalance	Beep continuously	Fault LED lit
18	Soft start failed	Beep continuously	Fault LED lit
19	UPS Inside Over Temperature	Twice per second	Fault LED lit
20	Heatsink Over Temperature	Twice per second	Fault LED lit
26	Battery over voltage	Once per second	Fault LED blinking
29	Output Short-circuit	Once per second	Fault LED blinking
30	Input current limit	Once per second	Fault LED blinking
31	Bypass over current	Once per second	BPS LED blinking
32	Overload	Once per second	INV or BPS LED blinking
33	No battery	Once per second	Battery LED blinking
34	Battery under voltage	Once per second	Battery LED blinking
35	Battery low pre-warning	Once per second	Battery LED blinking
36	Over load time out	Once per 2 seconds	Fault LED blinking
37	DC component over limit.	Once per 2 seconds	INV LED blinking
39	Mains volt. Abnormal	Once per 2 seconds	Battery LED lit
40	Mains freq. abnormal	Once per 2 seconds	Battery LED lit
41	Bypass Not Available		BPS LED blinking
42	Bypass unable to trace		BPS LED blinking
43	Inverter on invalid		
44	Not at Inverter side		

4. Troubleshooting



If the UPS system does not operate correctly, please solve the problem by using the table below.

Symptom	Possible cause	Remedy
No indication and alarm even though the mains is normal.	The AC input power is not connected well.	Check if input power cord firmly connected to the mains.
	The AC input is connected to the UPS output.	Plug AC input power cord to AC input correctly.
Alarm code is shown as "33" and battery led blinking.	The external or internal battery is incorrectly connected.	Check if all batteries are connected well.
Alarm code is shown as "26" and battery led blinking.	Battery voltage is too high or the charger is fault.	Contact your dealer.
Alarm code is shown as "34" and battery led blinking	Battery voltage is too low or the charger is fault.	Contact your dealer.
Alarm code is shown as "32" and INV or BYPASS led blinking.	UPS is overload	Remove excess loads from UPS output.
Alarm code is shown as "29" and FAULT led light.	The UPS shut down automatically because short circuit occurs on the UPS output.	Check output wiring and if connected devices are in short circuit status.
Alarm code is shown as "9" and FAULT led light.	Fan fault.	Contact your dealer.
Alarm code is shown as "01,02, 15,16,17,18"	A UPS internal fault has occurred.	Contact your dealer.
Battery backup time is shorter than nominal value	Batteries are not fully charged	Charge the batteries for at least 5 hours and then check capacity. If the problem still persists, consult your dealer.
	Batteries defect	Contact your dealer to replace the battery.

5. Storage and Maintenance

Operation

The UPS system contains no user-serviceable parts. If the battery service life (3~5 years at 25°C ambient temperature) has been exceeded, the batteries must be replaced. In this case, please contact your dealer.

 Ph	 Ph	Be sure to deliver the spent battery to a recycling facility or ship it to your dealer in the replacement battery packing material.
---	---	---

Storage

Before storing, charge the UPS 5 hours. Store the UPS covered and upright in a cool, dry location. During storage, recharge the battery in accordance with the following table:

Storage Temperature	Recharge Frequency	Charging Duration
-25°C - 40°C	Every 3 months	1-2 hours
40°C - 45°C	Every 2 months	1-2 hours

6. Specification

MODEL	1KVA(S)	1KVA(H)- B	1KVA(H)	2KVA(S)	2KVA(H)- B	2KVA(H)	3KVA(S)	3KVA(H)- B	3KVA(H)
PHASE	Single phase with ground								
Capacity (VA/Watts)	1000VA / 900W			2000VA / 1800W			3000VA / 2700W		
INPUT									
Nominal voltage	200/208/220/230/240VAC								
Operating voltage range	Low line transfer	160Vac±5% @100%-80% load; 140Vac±5% @80%-70% load; 120Vac±5% @70%-60% load; 110Vac±5% @60%-0% load; (Ambient Temp. <35°C)							
	Low line come back	175Vac±5% @100%-80% load; 155Vac±5% @80%-70% load; 135Vac±5% @70%-60% load; 125Vac±5% @60%-0% load; (Ambient Temp. <35°C)							
	High line transfer	300Vac ±5%							
	High line come back	290Vac ±5%							
Operating frequency range	40-70Hz								
Power factor	0.99@100% load(Nominal Input Voltage)								
Bypass voltage range	Bypass high voltage point 230-264: setting the high voltage point in LCD from 230Vac to 264Vac. (Default: 264Vac) Bypass low voltage point 170-220: setting the low voltage point in LCD from 170Vac to 220Vac. (Default: 170Vac)								
Generator input	Support								
OUTPUT									
Output voltage	200/208/220/230/240Vac								
Power factor	0.9								
Voltage regulation	±1%								
Frequency	Line Mode (synchronized range)	47-53Hz or 57-63Hz							
	Bat. Mode	(50/60±0.1)Hz							
Crest factor	3:1								
Harmonic distortion (THDv)	≤3% THDwith linear load ≤6% THD with non linear load								
Waveform	Pure Sinewave								
Transfer time	AC mode <-> Batt. mode	Zero							
	Inverter <-> bypass	4ms(Typical)							
Efficiency	88%(AC mode) 85%(DC mode)			92%(AC mode) 88%(DC mode)			92%(AC mode) 90%(DC mode)		
BATTERY									

Battery Type	12V9A H	depends on the capacity of external batteries		12V9A H	depends on the capacity of external batteries		12V9AH	depends on the capacity of external batteries	
Numbers	2	2	3	4	4	6	6	6	8
Backup time	Long run unit depends on the capacity of external batteries								
Typical recharge time(standard modle)	4 hours recover to 90% capacity (Typical)								
Charging voltage	27.4 VDC ±1%	27.4 VDC ±1%	41.0 VDC ±1%	54.7 VDC ±1%	54.7 VDC ±1%	82.1 VDC ±1%	82.1 VDC ±1%	82.1 VDC ±1%	109.4 VDC ±1%
Charge current	1A	12A max		1A	12A max		1A	12A max	
SYSTEM FEATURES									
Overload @35°C	Line Mode Battery Mode	<p style="text-align: center;">Ambient Temp.<35°C</p> <p>105%~110%: UPS transfer to bypass after 10minuteswhen the utility is normal 110%~130%: UPS transfer to bypass after 1minute when the utility is normal 130%~150%: UPS transfer to bypass after 5 seconds when the utility is normal >150%: UPS transfer to bypass immediately when the utility is normal</p> <p style="text-align: center;">35°C<Ambient Temp.<40°C</p> <p>105%~110%: UPS transfer to bypass after 1minute when the utility is normal 110%~130%: UPS transfer to bypass after 5 seconds when the utility is normal >130%: UPS transfer to bypass immediately when the utility is normal</p>							
		Hold Whole System							
Short Circuit	Line Mode: Switch to Bypass; Backup Mode: Shut down UPS immediately								
Overheat	Alarm and Switch off								
Low battery voltage	Shut down UPS immediately								
EPO (optional)	Line Failure, Battery Low, Overload, System Fault								
Audible & Visual alarms	USB(or RS232), SNMPcard(optional), Relay card (optional)								
Comunication interface									
ENVIRONMENTAL									
Operating temperature	0°C~40°C								
Storage temperature	-25°C~55°C								
Humidity range	20-90 % RH @ 0- 40°C (non-condensing)								
Altitude	< 1000m								
Noise level	Less than 50dBA at 1 Meter								
PHYSICAL									
Dimension WxHxD (mm)	144*209*293			144*209*399			191*337*460	144*209*399	
Net Weight (kg)	8.9	4.2		16.2	6.3		24.8	6.5	
STANDARDS									
Safety	IEC/EN62040-1,IEC/EN60950-1								
EMC	IEC/EN62040-2,IEC61000-4-2,IEC61000-4-3,IEC61000-4-4, IEC61000-4-5,IEC61000-4-6,IEC61000-4-8								

* Derate to 80% of capacity when the output voltage is adjusted to 200/208VAC

** Product specifications are subject to change without further notice.